

**1 or 2 Pole electromechanical step relay with electrically separate coil and contact circuits**

- Choice of 6 switching sequences
- Screw terminal connections
- AC coil
- Panel mount
- Cadmium free contact material

26.01/02/04/06/08/03  
Screw terminal



- Single phase switch 1 NO (SPST-NO)

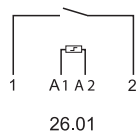

- Double phase switch 2 NO (DPST-NO)

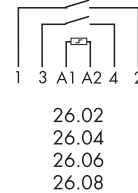

- 1 NO + 1 NC (SPST-NO + SPST-NC)

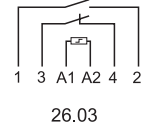

For outline drawing see page 4

**Contact specification**

Number of contacts		1 NO (SPST-NO)	2 NO (DPST-NO)	1NO+1NC (SPST-NO+SPST-NC)
Rated current/Maximum peak current	A	10/20	10/20	10/20
Rated voltage/ Maximum switching voltage	V AC	250/400	250/400	250/400
Rated load AC1	VA	2500	2500	2500
Rated load AC15 (230 V AC)	VA	500	500	500
Nominal lamp rating:				
230 V incandescent/halogen W		800	800	800
fluorescent tubes with electronic ballast W		400	400	400
fluorescent tubes with electromechanical ballast W		360	360	360
CFL W		200	200	200
230 V LED W		200	200	200
LV halogen or LED with electronic ballast W		200	200	200
LV halogen or LED with electromechanical ballast W		400	400	400
Minimum switching load	mW (V/mA)	1000 (10/10)	1000 (10/10)	1000 (10/10)
Standard contact material		AgNi	AgNi	AgNi

**Coil specification**

Nominal voltage (UN)	V AC (50 Hz)	12 - 24 - 48 - 110 - 230	12 - 24 - 48 - 110 - 230	12 - 24 - 48 - 110 - 230
	V DC	—	—	—
Rated power AC/DC	VA (50 Hz)/W	4.5/—	4.5/—	4.5/—
Operating range	AC (50 Hz)	(0.8...1.1)U <sub>N</sub>	(0.8...1.1)U <sub>N</sub>	(0.8...1.1)U <sub>N</sub>
	DC	—	—	—

**Technical data**

Mechanical life AC/DC	cycles	300 · 10 <sup>3</sup>	300 · 10 <sup>3</sup>	300 · 10 <sup>3</sup>
Electrical life at rated load in AC1	cycles	100 · 10 <sup>3</sup>	100 · 10 <sup>3</sup>	100 · 10 <sup>3</sup>
Minimum/Maximum impulse duration		0.1 s/1 h (according to EN 60669)	0.1 s/1 h (according to EN 60669)	0.1 s/1 h (according to EN 60669)
Insulation between coil and contacts (1.2/50 μs)	kV	4	4	4
Ambient temperature range	°C	-40...+40	-40...+40	-40...+40
Protection category		IP 20	IP 20	IP 20

**Approvals** (according to type)



## Ordering information

Example: 26 series screw terminal, panel mount relay, double phase switch 2 NO (DPST-NO) 10 A contacts, coil rated 12 V AC.

2 6 . 0 2 . 8 . 0 1 2 . 0 . 0 . 0 . 0

<b>Series</b>	2 6 . 0	<b>Coil voltage</b>	0 0 . 0 . 0
<b>Type</b>	0 = Screw terminal	See coil specifications	
<b>No. of poles</b>	2 = Double phase switch 2 NO (DPST-NO)	<b>Coil version</b>	8 = AC (50 Hz)
	1 = Single phase switch 1 NO (SPST-NO)		
	2 = Double phase switch 2 NO (DPST-NO)		
	3 = Double phase switch 1 NO + 1 NC (SPST-NO + SPST-NC)		
	4 = 4 sequences double phase switch 2 NO (DPST-NO)		
	6 = 3 sequences double phase switch 2 NO (DPST-NO)		
	8 = 4 sequences double phase switch 2 NO (DPST-NO)		

## Technical data

## Insulation

Dielectric strength				
between supply and contacts	V AC	3500		
between open contacts	V AC	2000		
between adjacent contacts	V AC	2000		

## Other data

		26.01, 26.03, 26.08	26.02, 26.04, 26.06		
Power lost to the environment					
with rated current and coil de-energised W		0.9	1.8		
 Screw torque	Nm	0.8	0.8		
Max. wire size		solid cable	stranded cable	solid cable	stranded cable
	mm <sup>2</sup>	1 x 4 / 2 x 2.5	1 x 2.5 / 2 x 2.5	1 x 4 / 2 x 2.5	1 x 2.5 / 2 x 2.5
	AWG	1x12 / 2x14	1 x 14 / 2 x 14	1 x 12 / 2 x 14	1 x 14 / 2 x 14

## Coil specifications

## AC version data

Nominal voltage $U_N$	Coil code	Operating range		Resistance R	Consumption I at $U_N$ (50 Hz)
		$U_{min}$	$U_{max}$		
V		V	V	$\Omega$	mA
12	8.012	9.6	13.2	17	370
24	8.024	19.2	26.4	70	180
48	8.048	38.4	52.8	290	90
110	8.110	88	121	1500	40
230	8.230	184	253	6250	20

Type	Number of steps	Sequence			
		1	2	3	4
26.01	2				
26.02	2				
26.03	2				
26.04	4				
26.06	3				
26.08	4				

## Wiring diagrams

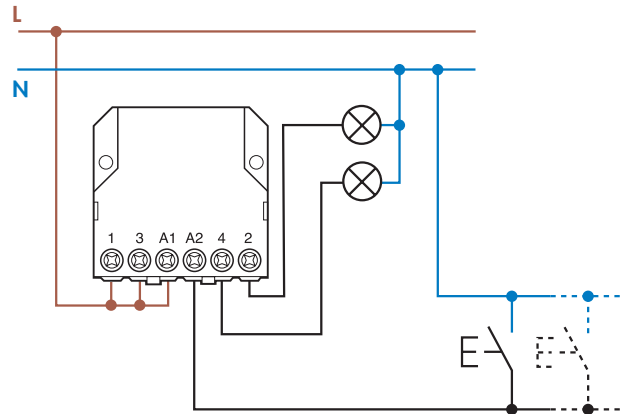

## Accessories

### for 12 and 24 V DC control applications

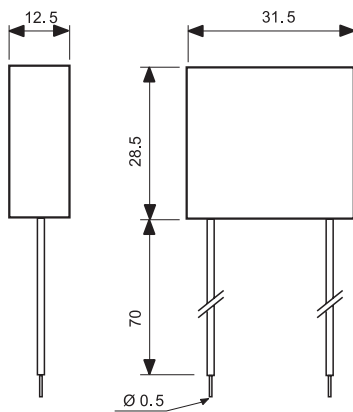

**Type: 026.9.012**

Nominal voltage: 12 V DC  
Max temperature: +40 °C  
Operating range: (0.9...1.1)U<sub>N</sub>

**Type: 026.9.024**

Nominal voltage: 24 V DC  
Max temperature: +40 °C  
Operating range: (0.9...1.1)U<sub>N</sub>

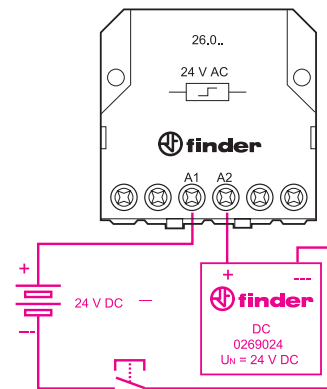

Example of wiring for 24 V DC control application.

### Module for use with illuminated push buttons (230 V AC applications)

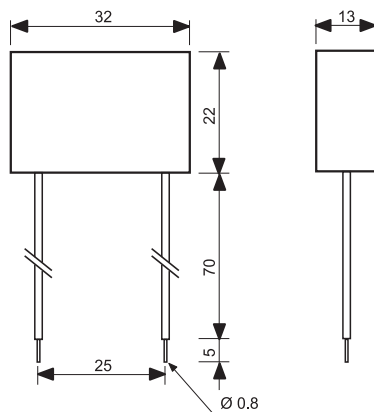

**Type 026.00**

Sealed construction, 7.5 cm insulated flexible wire termination.

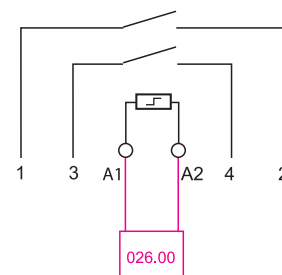

**Example of wiring diagram of type 026.00**

This module is necessary when using between 1 and a maximum of 15 illuminated push buttons in the coil circuit (Each 1 mA max, 230 V AC). It must be connected in parallel to the coil of the relay (see diagram).

Outline drawings

26.01  
Screw terminal

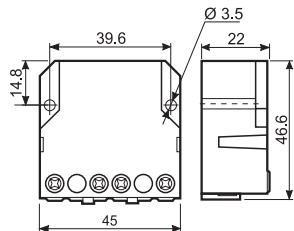

26.02 / 04 / 06 / 08  
Screw terminal

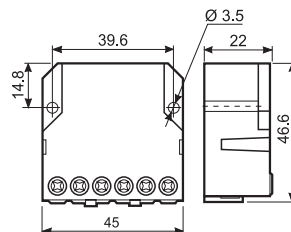

26.03  
Screw terminal

